



Page 5-2

**ADXM...BP**

- IEC rated starter current Ie 6 to 45A ratings
- IEC rated motor power 2.2 to 22kW at 400VAC / UL/CSA ratings 5 to 40HP at 600HP
- Integrated by-pass relay
- Total protection against over-temperature
- Acceleration and deceleration time adjustable on front
- LED indicator of starter status
- Fixing on 35mm DIN rail.



Page 5-3

**ADX...BP**

- For standard duty, IEC starting current 3.5•Ie
- IEC rated starter current Ie 22 to 231A ratings
- IEC rated motor power, 9.2 to 110kW at 380/415VAC
- Reduced voltage soft starter with torque control and built-in by-pass contactor
- Maximum starting current limitation
- PC remote control supervision
- Modbus®-RTU and property ASCII communication protocols
- LCD backlit screen.



Page 5-3

**ADX...B**

- For severe duty, IEC starting current 5•Ie
- IEC rated starter current Ie 17 to 245A ratings
- IEC rated motor power, 7.5 to 132kW at 380/415VAC
- Reduced voltage soft starter with torque control and built-in by-pass contactor
- Maximum starting current limitation
- PC remote control supervision
- Modbus®-RTU and property ASCII communication protocols
- LCD backlit screen.



Page 5-3

**ADX**

- For severe duty, IEC starting current 5•Ie
- IEC rated starter current Ie, 310A to 1200A ratings
- IEC rated motor power, 160kW to 630kW at 380/415VAC
- Reduced voltage soft starter with torque control, predisposed for external by-pass contactor
- Maximum starting current limitation
- PC remote control supervision
- Modbus®-RTU and property ASCII communication protocols
- LCD backlit screen.

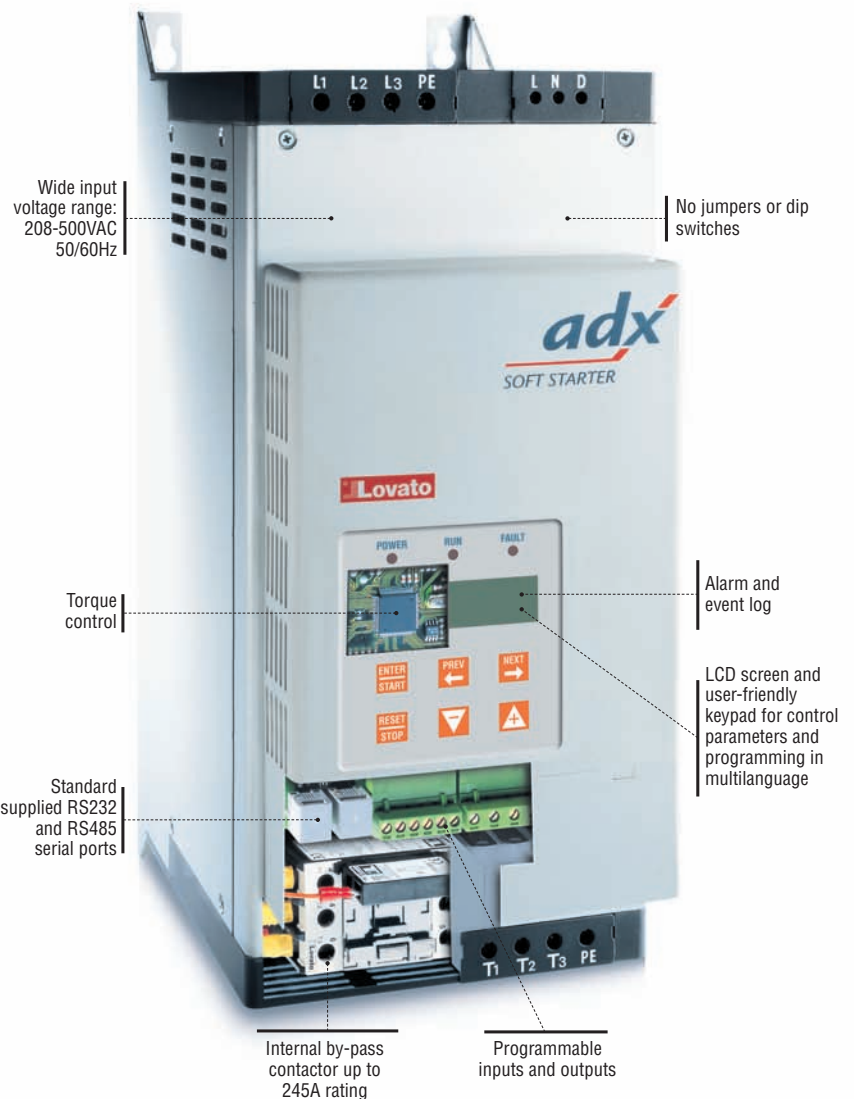



- 6A to 1200A starter ratings
- Standard and severe-duty types
- Internal by-pass contactor up to 245A rating
- Torque ramp starting
- Total motor protection incorporated
- Clock calendar
- Digital control and adjustment
- RS232 and RS485 serial ports for remote supervision and control
- Modbus®-RTU and proprietary ASCII communication protocols.

## Soft starters

SEC. - PAG.

ADXM...BP type with integrated by-pass relay .....	5 - 2
ADX...BP type for standard duty with integrated by-pass contactor .....	5 - 3
ADX...B type for severe duty with integrated by-pass contactor .....	5 - 3
ADX... type for severe duty predisposed for external by-pass contactor .....	5 - 3
Remote keypad and accessories .....	5 - 4
Remote control software .....	5 - 5

## Dimensions

5 - 6

## Technical characteristics

5 - 8

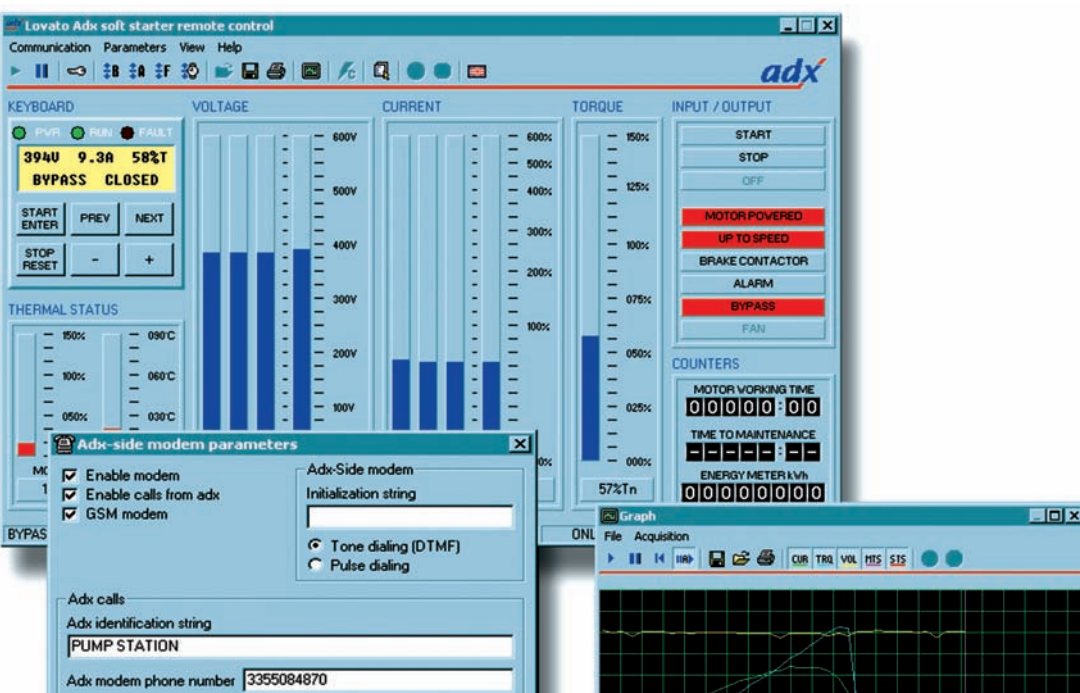

## ADXM...BP type



51 ADXM 06BP  
51 ADXM 12BP  
51 ADXM 18BP



51 ADXM 25BP  
51 ADXM 38BP  
51 ADXM 45BP

Order code	IEC Rated starter current Ie in AC-53b	Rated motor power IEC UL/CSA		Qty per pkg	Wt
	[A]	[kW]	[HP]	n°	[kg]

With integrated by-pass relay.  
Three-phase 400VAC motor control.

51 ADXM 06BP	6	2.2	3	1	0.580
51 ADXM 12BP	12	5.5	7.5	1	0.580
51 ADXM 18BP	18	7.5	10	1	0.580
51 ADXM 25BP	25	11	15	1	0.800
51 ADXM 38BP	38	18.5	20	1	0.800
51 ADXM 45BP	45	22	25	1	0.800

With integrated by-pass relay.  
Three-phase 220VAC motor control.

51 ADXM 06BP A220	6	1.1	1.5	1	0.580
51 ADXM 12BP A220	12	3	3	1	0.580
51 ADXM 18BP A220	18	4	5	1	0.580
51 ADXM 25BP A220	25	5.5	10	1	0.800
51 ADXM 38BP A220	38	11	10	1	0.800
51 ADXM 45BP A220	45	11	15	1	0.800

With integrated by-pass relay.  
Three-phase 480VAC motor control.

51 ADXM 06BP A480	6	2.2	5	1	0.580
51 ADXM 12BP A480	12	5.5	7.5	1	0.580
51 ADXM 18BP A480	18	7.5	10	1	0.580
51 ADXM 25BP A480	25	15	20	1	0.800
51 ADXM 38BP A480	38	22	25	1	0.800
51 ADXM 45BP A480	45	30	30	1	0.800

With integrated by-pass relay.  
Three-phase 600VAC motor control.

51 ADXM 06BP A600	6	3	5	1	0.580
51 ADXM 12BP A600	12	7.5	10	1	0.580
51 ADXM 18BP A600	18	11	15	1	0.580
51 ADXM 25BP A600	25	18.5	25	1	0.800
51 ADXM 38BP A600	38	22	30	1	0.800
51 ADXM 45BP A600	45	30	40	1	0.800

### ADXM 06/12/18BP ADJUSTMENTS

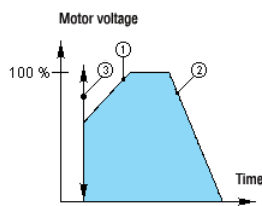
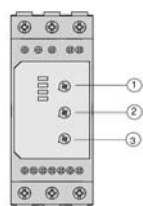

- ① Ramp-up time 0.5 to 10s. Time from zero to full load voltage.
- ② Ramp-down time 0.5 to 20s. Time from full load voltage to zero.
- ③ Initial torque 0 to 85% of voltage at the beginning of the ramp-up function.

### ADXM 25/38/45BP ADJUSTMENTS

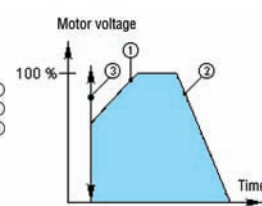
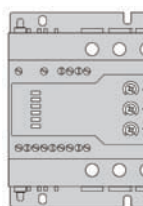

- ① Ramp-up time 1 to 10s. Time from zero to full load voltage.
- ② Ramp-down time 1 to 30s. Time from full load voltage to zero.
- ③ Initial torque 0 to 70% of voltage at the beginning of the ramp-up function.

### General characteristics

ADXM...BP is a compact type of soft starter, for three phase squirrel-cage induction motors; soft starts and soft stops rated motor load currents up to 45A. Starting and stopping times as well as initial torque can be independently adjusted by built-in potentiometers. ADXM...BP reduces the mechanical load on motors, shafts, gearboxes and drive belts.

Main features are:

- For three phase induction motors up to 22kW / 25HP at 400VAC and 30kW / 40HP at 600VAC
- 35mm DIN (IEC/EN 60715) rail mounting
- Integrated by-pass relay
- Full protection against overtemperature (ADXM 25/38/45BP)
- Simple setting and installation
- Ideal for conveyor belts, compressors, pumps, hoisting devices, blowers, fans, mixers.

### Operational characteristics

- Number of controlled phases: 2
- Controlled input voltage L1-L2-L3:
  - 400VAC -15...+10% (ADXM...BP)
  - 220VAC -15...+10% (ADXM...BP A220)
  - 400VAC -15...+10% (ADXM...BP A480)
  - 600VAC -15...+10% (ADXM...BP A600)
- Frequency range: 50/60Hz  $\pm$ 10Hz self-configurable
- Auxiliary supply voltage:
  - A1-A2 - 24-110VAC/DC  $\pm$ 15% (ADXM 06/12/18BP...)
  - A1-A3 - 110-480VAC  $\pm$ 15% (ADXM 06/12/18BP...)
  - A1-A2 - 24-550VAC/DC  $\pm$ 15% (ADXM 25/38/45BP / A220 / A480)
  - A1-A2 24-600VAC/DC  $\pm$ 10% (ADXM 25/38/45BP A600)
- Start time adjustment (ramp up):
  - 0.5 to 10s (ADXM 06/12/18BP...)
  - 1 to 10s (ADXM 25/38/45BP...)
- Stop time adjustment (ramp down):
  - 0.5 to 20s (ADXM 06/12/18BP...)
  - 1 to 30s (ADXM 25/38/45BP...)
- Start torque adjustment (initial torque):
  - 0-85% voltage (ADXM 06/12/18BP...)
  - 0-70% voltage (ADXM 25/38/45BP...)
- Degree of protection: IP20
- LED indicators:

	ADXM 06/12/18BP	LED
Power on	Green LED	POWER ON
Ramp up/down	Yellow LED (constantly on)	RAMPING
By-pass relay	Yellow LED (constantly on)	BYPASS

	ADXM 25/38/45BP	LED
Power on	Green LED	POWER ON
Ramp up/down	Yellow LED (flashing)	RAMPING
By-pass relay	Yellow LED (constantly on)	BYPASS

Overtemperature inside starter	Red LED (flashing)	OVERHEAT
Overtemperature in motor (PTC)	Red LED (constantly on)	
Phase failure/loss①	Red LED (flashing)	WRONG SEQ
Wrong phase sequence①	Red LED (fast flashing)	
Voltage too low	Red LED (slow flashing)	

① These protections are active at power on only.

### Certifications and compliance

Certifications obtained: GOST; UL Listed for USA and Canada (File E223223) as "Solid-state motor controllers". Compliant to standards: IEC/EN 60947-1, IEC/EN 60947-4-2, UL508, CSA C22-2 n° 14.

## ADX type



51 ADX 0022BP - 51 ADX 0048BP  
51 ADX 0017B - 51 ADX 0045B



51 ADX 0058BP - 51 ADX 0092BP  
51 ADX 0060B - 51 ADX 0085B



51 ADX 0114BP - 51 ADX 0126BP  
51 ADX 0110B - 51 ADX 0125B

Order code	IEC rated starter current Ie	IEC rated motor power (380/415V)	Qty per pkg	Wt
	[A]	[kW]	n°	[kg]

For standard duty (starting current 3.5•Ie).  
With integrated by-pass contactor.

51 ADX 0022BP	22	9.2	1	7.900
51 ADX 0034BP	34	15	1	8.000
51 ADX 0048BP	48	22	1	8.300
51 ADX 0058BP	58	26	1	14.900
51 ADX 0068BP	68	30	1	14.900
51 ADX 0082BP	82	37	1	14.900
51 ADX 0092BP	92	45	1	15.700
51 ADX 0114BP	114	55	1	15.700
51 ADX 0126BP	126	63	1	28.000
51 ADX 0150BP	150	75	1	36.000
51 ADX 0196BP	196	92	1	36.000
51 ADX 0231BP	231	110	1	36.000

For severe duty (starting current 5•Ie).  
With integrated by-pass contactor.

51 ADX 0017B	17	7.5	1	7.900
51 ADX 0030B	30	15	1	8.000
51 ADX 0045B	45	22	1	8.300
51 ADX 0060B	60	30	1	14.900
51 ADX 0075B	75	37	1	14.900
51 ADX 0085B	85	45	1	14.900
51 ADX 0110B	110	55	1	15.700
51 ADX 0125B	125	59	1	15.700
51 ADX 0142B	142	75	1	34.000
51 ADX 0190B	190	90	1	37.000
51 ADX 0245B	245	132	1	37.000

For severe duty (starting current 5•Ie).  
Predisposed for external by-pass contactor.

51 ADX 0310	310	160	1	50.000
51 ADX 0365	365	200	1	50.000
51 ADX 0470	470	250	1	90.000
51 ADX 0568	568	315	1	90.000
51 ADX 0640	640	355	1	110.000
51 ADX 0820	820	440	1	170.000
51 ADX 1200	1200	630	1	185.000

### General characteristics

ADX is a reduced voltage soft starter with torque control and maximum starting current limit. It is used for the progressive starting and stopping of asynchronous three-phase squirrel-cage motors.

The integrated by-pass contactor ADX...BP or ADX...B types only, drastically limits dissipation, as a result equipment for electric panel cooling ventilation can be eliminated and the enclosure size can be reduced as well.

### CONTROL

During starting: Torque control acceleration, current limit control and booster.

During stopping: Torque control deceleration, dynamic braking and free-wheel.

In emergency conditions: Starting without protections, direct-on-line starting using integrated by-pass contactor.

Remote control: PC supervision by connection with RS232/RS485 converter, modem or GSM modem.

Automatic call function (Autocall) in case of alarm conditions by sending a message to a cellular phone (SMS-Short Message Service) and/or to a mailbox. Property ASCII and Modbus®-RTU communication protocols.

### KEYPAD OPERATIONS

- Liquid-crystal backlight 2-line 16-character display
- Multilanguage capability (Italian, English, French, Spanish)
- Basic, advanced and function programming menus
- Keypad stop and start
- Motor and mains parameter readings:
  - line voltage values (L-L)
  - phase current
  - active and apparent power values per phase
  - power factor per phase
  - kWh
- Time sequential events log
- Clock calendar with backup battery.

### PARTICULAR FUNCTIONS

Digital inputs and programmable relay outputs. Analog input (0...10V, 0...20mA or 4...20mA) for ramp acceleration and/or deceleration, motor starting and stopping control thresholds, programmable relay enable and disable control thresholds. Analog output (0...10V, 0...20mA or 4...20mA) for current, torque, motor thermal status and power factor readings. Input programming for second motor.

### PROTECTIONS

- Motor: Dual thermal protection class (one during starting phase and the other during running) or by PTC sensor, locked rotor, current asymmetry, minimum torque and starting time too long
- Auxiliary voltage: Voltage value too low
- Power voltage: Phase failure, phase sequence and frequency out of limits
- Control inputs and analog output: Static 24VDC short-circuit protection with automatic resetting.
- Starter: Overcurrent, high temperature, SCR and by-pass contactor malfunction.

### Operational characteristics

- Input voltage:
  - 208-500VAC ±10% for ADX...BP and ADX...B①
  - 208-415VAC ±10% for ADX...②
- Mains frequency: 50-60Hz ±5%
- Auxiliary supply voltage: 208-240VAC ±10%
- Auxiliary consumption: 20VA
- Rated starter current Ie:
  - 22-231A for ADX...BP
  - 17-245A for ADX...B
  - 310-1200A for ADX...
- Motor current: 0.5-1 Ie
- Overload current:
  - 105% Ie continuous for ADX...BP and ADX...B
  - 115% Ie continuous for ADX...

### Certifications and compliance

Certifications obtained: GOST for all; CCC for ADX 0110B and ADX 0125B types only.

Compliant with standard: IEC/EN 60947-1, IEC/EN 60947-4-2.

① 208-600VAC ±10% on request.

② Voltages on request: higher than 415V to 690V maximum.

### Remote keypad for ADX... types



51 ADX TAST

### Accessories for ADX... types



51C4



4PX1

Order code	Description	Qty per pkg	Wt
		n°	[kg]
51 ADX TAST	Remote keypad 96x96mm, 2x16 backlit LCD, 208-240VAC supply c/w 3m/10ft long connecting cable	1	0.350
51 C2	PC ↔ ADX connecting cable, 1.8m/6ft long	1	0.090
51 C3	PC ↔ GSM modem connecting cable, 1.8m/6ft long <sup>①</sup>	1	0.210
51 C4	PC ↔ 4 PX1 converter drive connecting cable, 1.8m/6ft long	1	0.147
51 C5	ADX ↔ Analog modem connecting cable, 1.8m/6ft long <sup>①</sup>	1	0.111
51 C6	ADX ↔ 4 PX1 converter drive connecting cable, 1.8m/6ft long	1	0.102
51 C7	ADX ↔ GSM modem "FUNK-ANLAGEN" <sup>①</sup> connecting cable, 1.8m/6ft long	1	0.101
51 C8	ADX ↔ remote keypad connecting cable, 3m/10ft long	1	0.081
4 PX1	RS232/RS485 converter drive, opto-isolated, 220-240VAC <sup>②</sup>	1	0.600
31 PA 96X96	Protective cover (IP54)	1	0.077

<sup>①</sup> Consult Customer Service for modem details; see contact details on inside front cover.

<sup>②</sup> RS232/RS485 opto-isolated converter drive, 38,400 Baud-rate maximum, automatic or manual TRANSMIT line supervision, 220...240VAC ±10% supply (110-120VAC available on request).

#### General characteristics

The flush-mount ADX TAST remote keypad is identical to the one on board the soft starter except for the start and stop controls of the motor, which are permanently disabled. With this keypad, starter setup can be conducted, motor readings and operating data displayed and data and parameter transfer (ADX ↔ remote keypad) made, as well.

A backup copy of the starter data and parameter setup is obtainable with the transfer functions. In this way, quick and easy setup operations can be done especially with machines assembled in series.

The baud transmission rate, the contrast and backlight can also be adjusted by this keypad.

It is supplied standard with a 3 metre long cable and suitable connectors to complete the link to the ADX RS485 port. The three terminals of the keypad supply are removable.

For longer distances, this keypad can be connected to the ADX RS232 port via RS232/RS485 converter.

#### Advantages

- Flush mount
- Messages in selectable language
- Readings display
- Parameter setup
- Two-way data and parameter transfer.

#### Operational characteristics

- Auxiliary supply voltage: 208-240VAC ±10%
- Power consumption: 6.9VA
- Dissipation: 3.2W
- Mains frequency: 50/60Hz
- RS-485 port: RJ 4/4 connector
- Supply: Removable 3-pole 2.5 mm<sup>2</sup> terminal block.
- Display: 2 line, 16 character backlit LCD
- LED indication (3): POWER, RUN and FAULT
- Keys (6) ENTER/START, RESET/STOP, ←PREVIOUS, NEXT→, ▼ and ▲
- Ambient condition
  - Operating temperature: -10...+60°C
  - Storage temperature: -20...+70°C
- Flush mount enclosure
- Degree of protection on front: IP41; IP54 with protective cover.

#### Certifications and compliance

Certifications obtained: GOST.  
Compliant to standards: IEC/EN 61000-6-1 and IEC/EN 61000-6-3 for 4 PX1 types.

### Remote control software for ADX... types



51 ADX SW

Order code	Description	Qty per pkg	Wt
		n°	[kg]
51 ADX SW	PC-ADX remote control software with proprietary ASCII and Modbus® RTU protocols and a set of connecting cables 51 C2, 51 C3, 51 C5, 51 C7 for communications via RS232 port, analog or GSM modem	1	0.550

The remote control software consents to the PC supervision of all ADX soft starter functions, including: parameter set-up, real-time readout display, graphics of monitored parameter data during operation and starter events log display, each with time and date entry.

The PC-ADX connection is made by cable via the RS232 port, RS232/RS485 converter, analog or GSM modem.

The RS232 port is not suitable for permanent connections. The connection via modem permits the ADX starter to advise alarm conditions, that is an automatic link to the remote PC. GSM modem represents the ultimate solution for unmanned applications or where there are no telephone lines.

Interesting communications features are available with this type of modem, such as:

- SMS (Short Message Service): At alarm conditions, the ADX can send its ID and alarm code, with time and date entry. The advantage is the possibility of reaching service people, without delay, wherever they are located.
- E-mail (via Internet): a message with the same structure as mentioned above can be transmitted to a specified mailbox. The advantages of this type of message with respect to the SMS are that any communication, received through Internet mail server, is permanent and a vast number of these can be received and reviewed at any time.

#### General characteristics

- Display of all the monitored data by the ADX starter
- Virtual ADX keypad with access to all functions
- Parameter adjustment, only accessible with password, saving on disc and subsequent reloading on ADX starter
- Display of starter events log, showing time and date entry
- Graphics display of monitored data during operation
- Connection through RS232/RS485 converter or modem
- GSM-modem management with SMS or e-mail transmission
- AUTOCALL function for automatic PC call
- Program configuration in 4 languages (Italian, English, Spanish and French)
- Easy installation and set-up.

#### Advantages

- GSM network management for inaccessible applications where there are no telephone lines
- Call management during alarm conditions for SMS or email transmission
- No limit for remote control distance
- Possibility of remote motor starting
- Reduction of service time
- Reduction of maintenance and downtime.

#### Operational characteristics

Minimum hardware requirements of the personal computer:

- Windows 95/98 operating system
- Pentium 100MHz or faster processor
- At least 16MB of free RAM
- About 4MB of free hard disk memory
- Graphic card having at least 800x600 resolution
- One free serial interface port
- CD-ROM drive.

Example of main window frame using 51 ADX SW remote control software

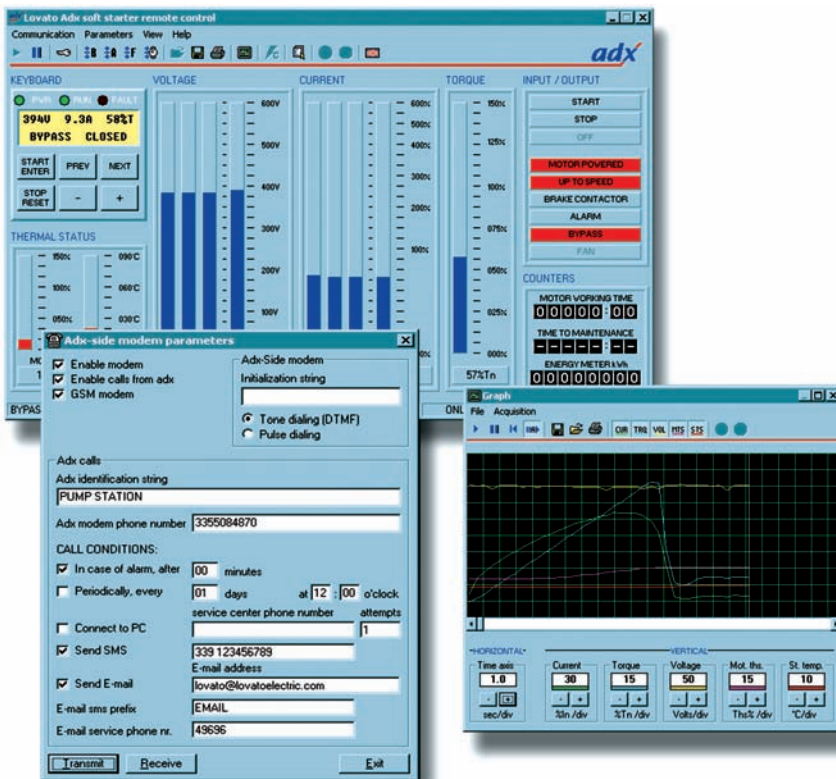

### Soft Starters ADXM 06BP - ADXM 18BP

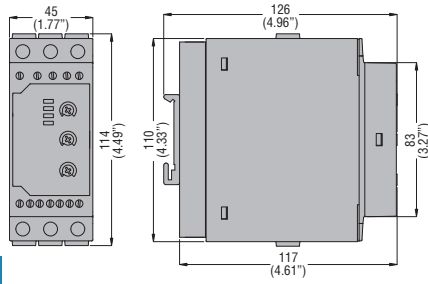

### ADXM 25BP - ADXM 45BP

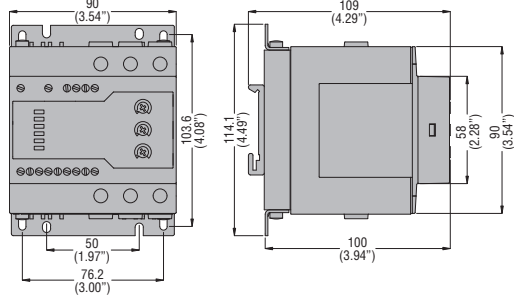

5

### ADX 0022BP - ADX 0126BP ADX 0017 B - ADX 0125 B

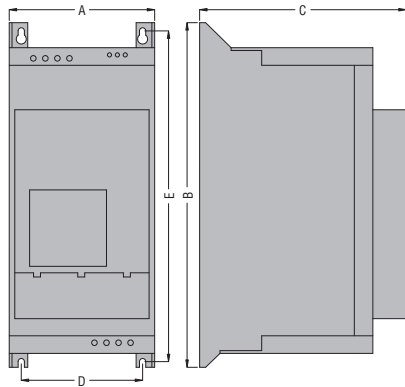

TYPE	A	B	C	D	E
ADX 0022BP	157 (6.18")	372 (14.64")	223 (8.78")	131 (5.16")	357 (14.05")
ADX 0034BP	157 (6.18")	372 (14.64")	223 (8.78")	131 (5.16")	357 (14.05")
ADX 0048BP	157 (6.18")	372 (14.64")	223 (8.78")	131 (5.16")	357 (14.05")
ADX 0058BP	157 (6.18")	534 (21.02")	250 (9.84")	132 (5.20")	517 (20.35")
ADX 0068BP	157 (6.18")	534 (21.02")	250 (9.84")	132 (5.20")	517 (20.35")
ADX 0082BP	157 (6.18")	534 (21.02")	250 (9.84")	132 (5.20")	517 (20.35")
ADX 0092BP	157 (6.18")	534 (21.02")	250 (9.84")	132 (5.20")	517 (20.35")
ADX 0114BP	157 (6.18")	584 (22.99")	250 (9.84")	132 (5.20")	567 (22.32")
ADX 0126BP	157 (6.18")	584 (22.99")	250 (9.84")	132 (5.20")	567 (22.32")
ADX 0017B	157 (6.18")	372 (14.64")	223 (8.78")	131 (5.16")	357 (14.05")
ADX 0030B	157 (6.18")	372 (14.64")	223 (8.78")	131 (5.16")	357 (14.05")
ADX 0045B	157 (6.18")	372 (14.64")	223 (8.78")	131 (5.16")	357 (14.05")
ADX 0060B	157 (6.18")	534 (21.02")	250 (9.84")	132 (5.20")	517 (20.35")
ADX 0075B	157 (6.18")	534 (21.02")	250 (9.84")	132 (5.20")	517 (20.35")
ADX 0085B	157 (6.18")	534 (21.02")	250 (9.84")	132 (5.20")	517 (20.35")
ADX 0110B	157 (6.18")	584 (22.99")	250 (9.84")	132 (5.20")	567 (22.32")
ADX 0125B	157 (6.18")	584 (22.99")	250 (9.84")	132 (5.20")	567 (22.32")

### ADX 0150BP - ADX 0231BP ADX 0142 B - ADX 0245 B

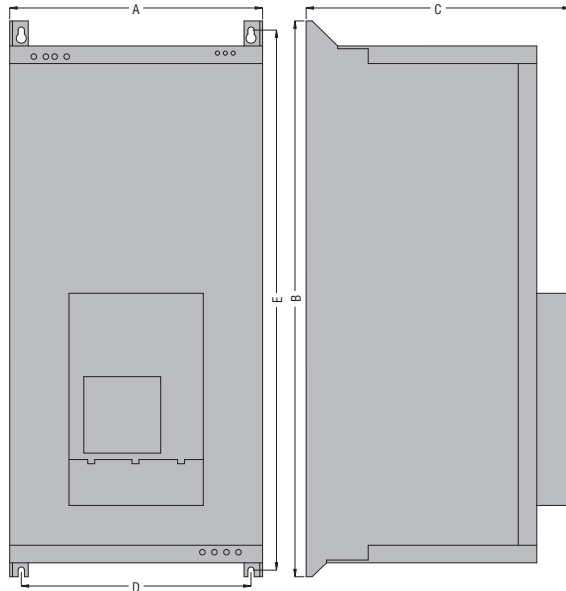

TYPE	A	B	C	D	E
ADX 0150BP	273 (10.75")	600 (23.62")	285 (11.22")	230 (9.05")	640 (25.20")
ADX 0196BP	273 (10.75")	680 (26.77")	310 (12.20")	230 (9.05")	640 (25.20")
ADX 0231BP	273 (10.75")	680 (26.77")	310 (12.20")	230 (9.05")	640 (25.20")
ADX 0142B	273 (10.75")	600 (23.62")	285 (11.22")	230 (9.05")	560 (25.20")
ADX 0190B	273 (10.75")	680 (26.77")	310 (12.20")	230 (9.05")	640 (25.20")
ADX 0245B	273 (10.75")	680 (26.77")	310 (12.20")	230 (9.05")	640 (25.20")

### Soft Starters ADX 0310 - ADX 1200

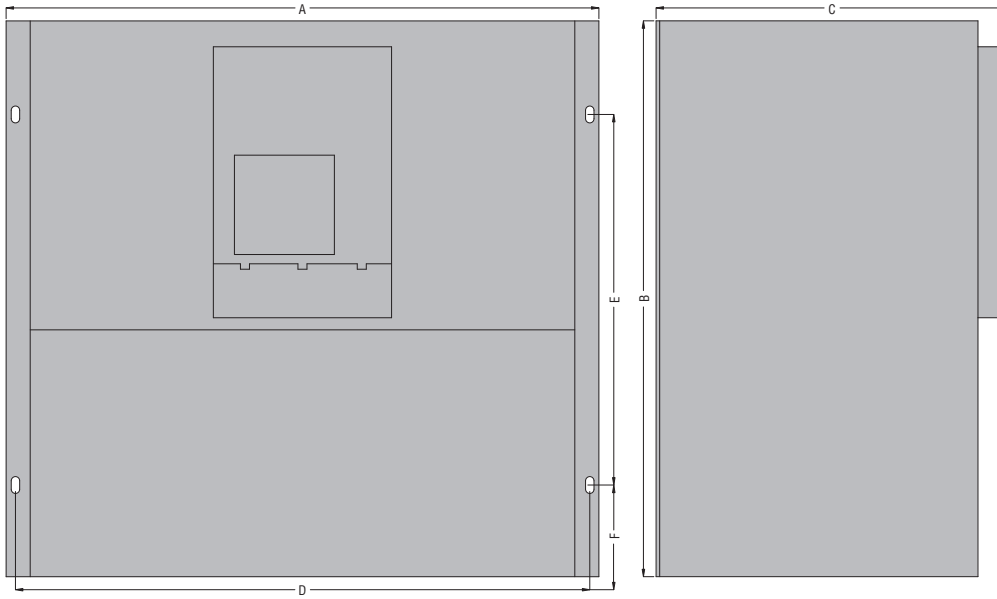

TYPE	A	B	C	D	E	F
ADX 0310	640 (25.20")	600 (23.62")	380 (14.96")	620 (24.41")	400 (15.75")	100 (3.94")
ADX 0365	640 (25.20")	600 (23.62")	380 (14.96")	620 (24.41")	400 (15.75")	100 (3.94")
ADX 0470	790 (31.10")	650 (25.59")	430 (16.93")	770 (30.31")	450 (17.72")	100 (3.94")
ADX 0568	790 (31.10")	650 (25.59")	430 (16.93")	770 (30.31")	450 (17.72")	100 (3.94")
ADX 0640	790 (31.10")	650 (25.59")	430 (16.93")	770 (30.31")	450 (17.72")	100 (3.94")
ADX 0820	910 (35.83")	950 (37.40")	442 (17.40")	830 (32.68")	920 (36.22")	①
ADX 1200	910 (35.83")	950 (37.40")	442 (17.40")	830 (32.68")	920 (36.22")	①

① Consult Customer Service; see contact details on inside front cover.

### Remote keypad ADX TAST

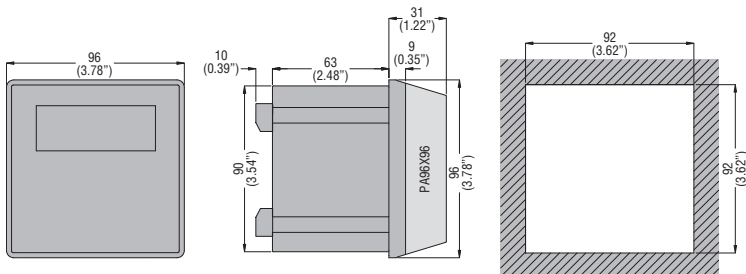



5

TYPE		ADXM 06BP	ADXM 12BP	ADXM 18BP	ADXM 25BP	ADXM 38BP	ADXM 45BP	
		(with integrated by-pass relay)			(with integrated by-pass relay)			
Motor	Type	Asynchronous three phase			Asynchronous three phase			
	Power	at 220VAC	1.1kW / 1.5HP	3kW / 3HP	4kW / 5HP	5.5kW / 10HP	11kW / 10HP	11kW / 15HP
		at 400VAC	2.2 kW / 3HP	5.5kW / 7.5HP	7.5kW / 10HP	11kW / 15HP	18.5kW / 20HP	22kW / 25HP
		at 480VAC	2.2kW / 5HP	5.5kW / 7.5HP	7.5kW / 10HP	15kW / 20HP	22kW / 25HP	30kW / 30HP
		at 600VAC	3kW / 5HP	7.5kW / 10HP	11kW / 15HP	18.5kW / 25HP	22kW / 30HP	30kW / 40HP
	Rated current	6A	12A	18A	25A	38A	45A	
UL/CSA ratings	Short circuit symmetrical	RMS 5kA for 220VAC, 400VAC and 480VAC types; 10kA for 600VAC type			5kA for 220VAC, 400VAC and 480VAC types; 10kA for 600VAC type			
	Fuse protection Fuse class / Amps up to 480VAC	URC / 25A max	URC / 40A max	URC / 40A max	URQ / 63A max	URQ / 80A max	URQ / 100A max	
	RK5 class for 600VAC	12A max	30A max	35A max	45A max	<160A max	<126A max	
	Max. operating temp.	60°C						
Power supply	Power circuit	220VAC -15 / +10% for ADXM...BPA220 types - 400VAC -15/+10% for ADXM...BP types 480VAC -15 / +10% for ADXM...BPA480 types - 600VAC -15 / +10% for ADXM...BPA600 types						
Auxiliary	For all types:	A1-A2: 24-110VAC/DC ±15% (1-5mA); A1-A3: 110-480VAC ±15% (1-5mA)			A1-A2: 24-550VAC/DC ±15% (<1.5mA) for ADXM...BP, ADXM...BPA220, ADXM...BPA480; A1-A2: 24-600VAC/DC ±10% for ADXM...BPA600 (<1.5mA)			
Frequency		50 or 60Hz ±10% self-configurable						
Starting method		Voltage ramp control						
Stopping method		Voltage ramp control						
Number of controlled phases		2						
Maximum number of starts/hour	at 40°C	250 (Overload cycle: 6A: AC-53B: 4-5: 4)	60 (Overload cycle: 12A: AC-53B: 4-5: 50)	60 (Overload cycle: 18A: AC-53B: 4-5: 50)	50 (Overload cycle: 25A: AC-53B: 4-5: 65)	40 (Overload cycle: 38A: AC-53B: 4-5: 85)	30 (Overload cycle: 45A: AC-53B: 4-5: 115)	
	at 50°C	100 (Overload cycle: 6A: AC-53B: 4-5: 26)	50 (Overload cycle: 12A: AC-53B: 4-5: 62)	50 (Overload cycle: 18A: AC-53B: 4-5: 62)	35 (Overload cycle: 25A: AC-53B: 4-5: 85)	20 (Overload cycle: 38A: AC-53B: 4-5: 175)	25 (Overload cycle: 45A: AC-53B: 4-5: 335)	
	at 60°C	100 (Overload cycle: 6A: AC-53B: 4-5: 62)	50 (Overload cycle: 12A: AC-53B: 4-5: 80)	50 (Overload cycle: 18A: AC-53B: 4-5: 110)	35 (Overload cycle: 25A: AC-53B: 4-5: 115)	20 (Overload cycle: 38A: AC-53B: 4-5: 135)	25 (Overload cycle: 45A: AC-53B: 4-5: 175)	
Dissipation with by-pass relay activated		20W			10W	13W	15W	
Protections	Motor	-			High temperature			
Cooling system		Natural			Natural			
STATUS INDICATION LEADS								
POWER ON	With power on	Green LED constantly on			Green LED constantly on			
RAMPING	Ramp up/down	Yellow LED constantly on			Yellow LED flashing			
BYPASS	By-pass relay activated	Yellow LED constantly on			Yellow LED constantly on			
OVERHEAT	Over temp. inside starter	-			Red LED flashing			
	Over temperature motor (PTC sensor)	-			Red LED constantly on			
WRONG SEQ	Wrong phase sequence (active at power on)	-			Red LED fast flashing			
PHASE LOSS	Phase failure/loss (active at power on)	-			Red LED flashing			
	Voltage too low	-			Red LED slow flashing			
AUXILIARY SUPPLY CONNECTIONS								
Number and type of terminals		7 cage clamp with M3 screw			7 cage clamp with M3 screw			
Conductor section min...max		Flexible w/o or c/w ferrule 0.5...1.5mm <sup>2</sup> / 22...12AWG			Flexible w/o or c/w ferrule 0.75...2.5mm <sup>2</sup> / 22...14AWG			
Stripping length		6mm / 0.25in			6mm / 0.25in			
Tightening torque		0.5Nm / .5lbin (Phillips bit 0)			4.5lbin / 0.5Nm (Phillips bit 0)			
POWER CIRCUIT CONNECTIONS								
Number and type of terminals		6 cage clamp with M4 screw			6 cage clamp with M5 screw			
Conductor section min...max		Flexible w/o or c/w ferrule 2.5...10mm <sup>2</sup> / 14... 8AWG			Flexible w/o or c/w ferrule 0.75...1.6mm <sup>2</sup> / 14...4AWG			
Stripping length		8mm / 0.3in			10mm / 0.3in			
Tightening torque		2.5Nm / 22lbin (Pozidriv bit 2)			22lbin / 2.5Nm (Pozidriv bit 2)			
AMBIENT CONDITIONS								
Operating temperature		-20...+60°C						
Storage temperature		-50...+85°C						
Relative humidity		<95% with no condensation at 40°C						
Pollution degree		3						
Overvoltage category		3						
Altitude		1000m without derating; higher up derate starter current value 1% every 100m and 2000m maximum						
HOUSING								
Mounting		On 35mm DIN rail (IEC/EN 60715)						
Degree of protection		IP20						

TYPE		ADX...BP - ADX...B (with integrated by-pass contactor)	ADX... (prearranged for external by-pass contactor)
Motor	Type	Asynchronous three phase	
	Power	9.2-110kW (ADX...BP) 7.5-132kW (ADX...B)	160-630kW
	Rated current	22-231 (ADX...BP) 17-245A (ADX...B)	310-1200A
Supply voltage	Power circuit	208 - 500VAC ±10% standard (208-575VAC ±10% on request)	208 - 415VAC ±10% standard Other voltages up to 690VAC maximum on request)
	Rated supply voltage	208 - 240VAC ±10%	208 - 240VAC ±10%
	Frequency	50 or 60Hz ±5% self-configurable	
Starting	Torque ramp with maximum current control		
Stopping	Free wheel or torque ramp deceleration		
Braking	DC dynamic by external contactor		
Protections	Auxiliary supply	Voltage too low	
	Power supply	Phase failure, frequency out of limits, minimum and maximum voltage and phase sequence, 24VDC static short circuit	
	Motor	Overload at starting (trip class 2, 10A, 10, 15, 20, 25, 30, 35 and 40), overload during running (trip class 2, 10A, 10, 15, 20, 25 and 30), locked rotor, current asymmetry, minimum torque and maximum starting time	
	Starter	Overcurrent and high temperature	
	Analog inputs and outputs	24VDC static short circuit	
Functions	Clock calendar (RTC)	With back-up battery	
	Event log	20 event registrations in date and time sequential order	
	Operating data memory	Hour counter, one each for energy usage, number of startings, motor running and maintenance expiry	
	Multilanguage capability	Italian / English / Spanish / French	
Setup configuration	By incorporated or remote keypad or PC		
Keyboard	Display and LED indicators	LCD, 2 line x 16 character, backlight, POWER, RUN, FAULT	
	Membrane keys	ENTER/START, RESET/STOP, PREVIOUS, NEXT, ▲ and ▼	
	Setup parameters	Adjustment menus: basic, advanced, functions, clock and controls	
	Readings display	Voltage, current, power factor (cosφ), torque, power (kVA, kW, kvar) and energy usage	
	Graphic display	Current and torque	
	Display	Operating status, events, alarms, event log, data	
Control inputs	Voltage	24VDC (no need for external feeder)	
	Fixed functions	2 for starting and stopping/reset	
	Multifunction input (digital functions)	Free-wheel stopping, external alarm, motor preheat, on board control, alarm inhibition, thermal protection manual reset, cascade starting and keypad lock	
	Multifunction input (analog functions)	Motor protection via PTC probes, acceleration and/or deceleration ramp via analog input, analog input thresholds for motor starting and stopping, analog input thresholds for programmable relay enable and disable, PT100 input thresholds for motor starting and stopping and PT100 input thresholds for programmable relay enable and disable	
Relay outputs	Voltage and capacity	250VAC 5A (AC1)	
	Fixed functions	1 with 1 NO + 1NC (2 SPST) contacts for overall alarm	
	Programmable functions	3 each with 1 NO (SPST) contact for running motor, motor starting, braking, current tripping threshold, maintenance expiry, etc.	
Analog output	Format configuration	0-20mA, 4-20mA or 0-10V	
	Associated source	Current, torque, motor thermal status and power factor	
Communications interface	RS232 port	Setup and remote control	
	RS485 port	Used for remote keypad only	
Degree of protection	IP00		
Cooling system	Natural	22-48A (ADX...BP);	—
	Forced	58-231A (ADX...BP); 60-245A (ADX...B)	All types
<b>AMBIENT CONDITIONS</b>			
Operating temperature	-10...+45°C (higher up to maximum 55°C with derating)		
Storage temperature	-30°...+70°C		
Maximum altitude	1000m (higher up with derating)		
Maximum pollution degree	3		
Operating position	Vertical ±15°		

● IP20 for ADX0022BP to ADX0126BP and ADX0017B to ADX0125B only.